

Détecteur pour réfraction

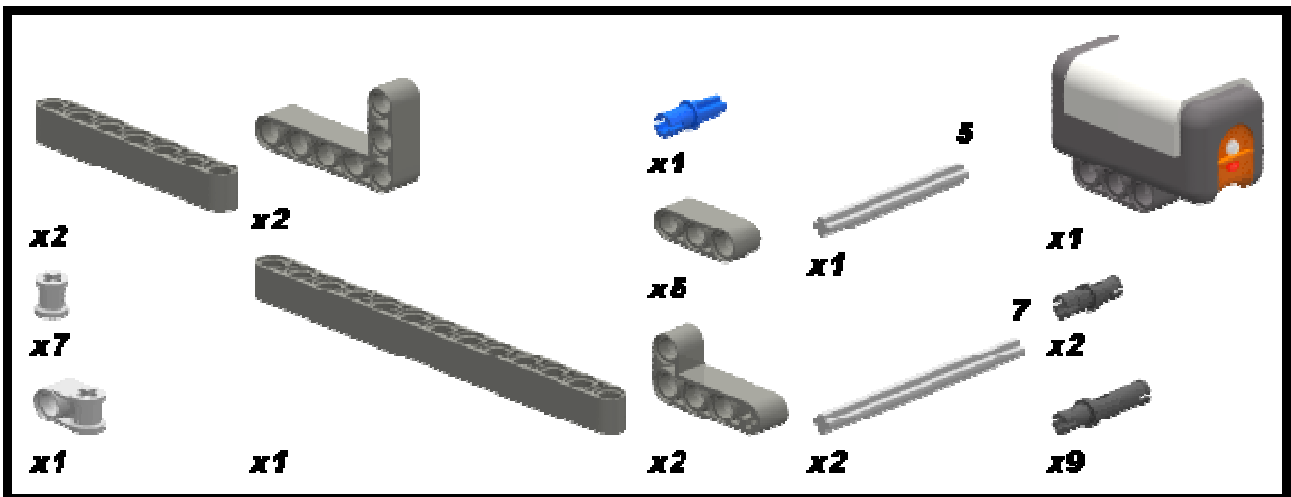

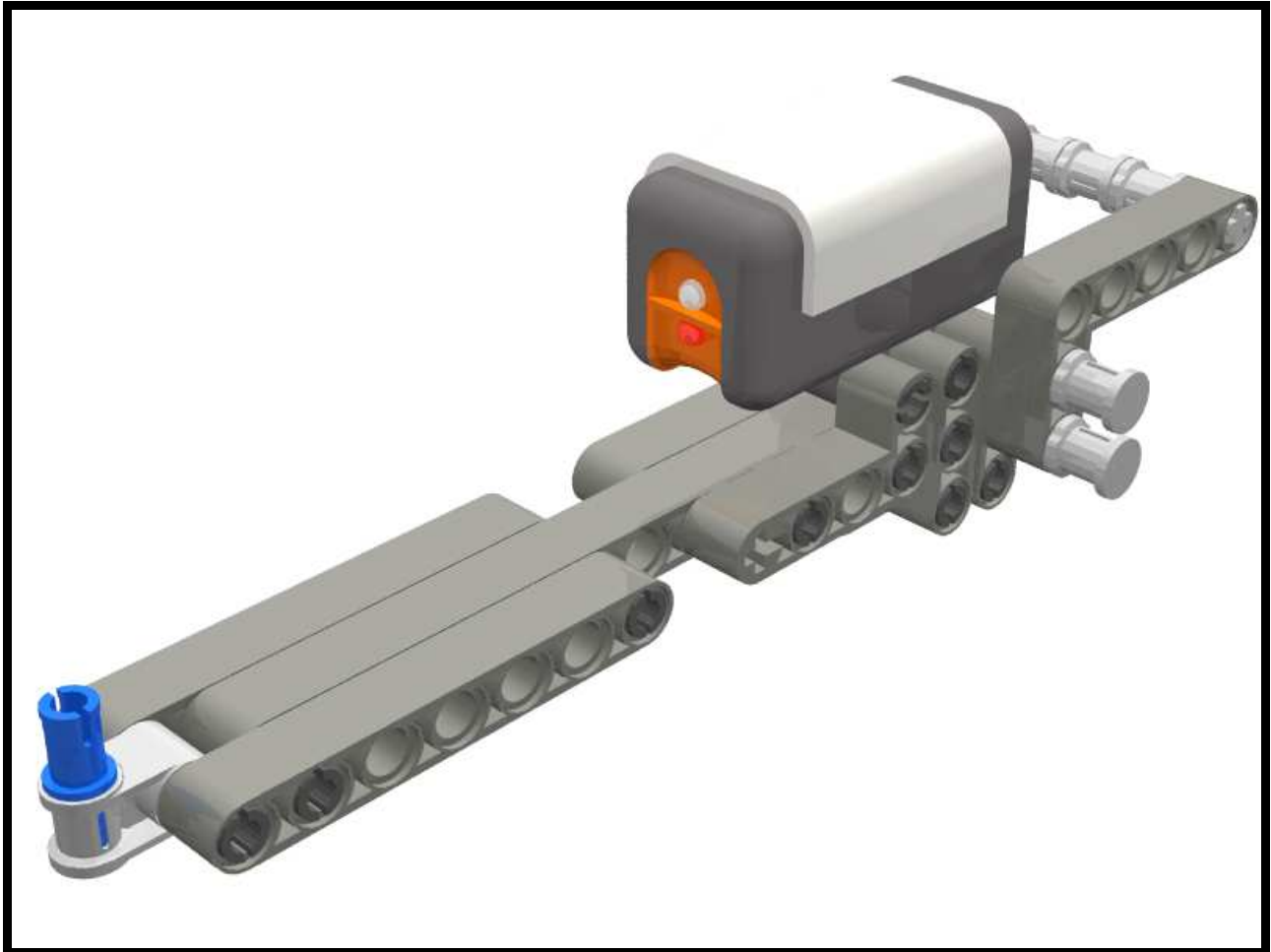

1



2





3



4

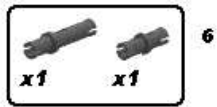
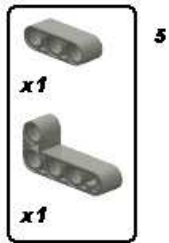



7



8

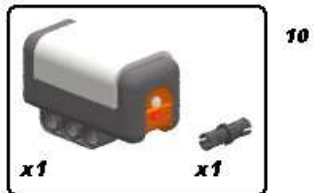

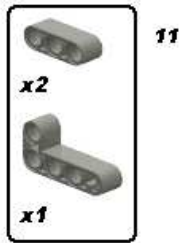

11

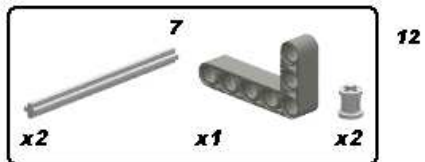

12

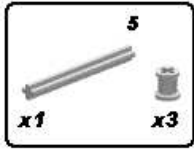

13



13

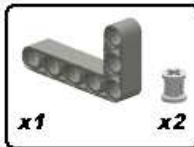

14



14